

# Memorandum of common provisions

## Restrictive covenants in a plan

### Section 91A Transfer of Land Act 1958

#### Privacy Collection Statement

The information in this form is collected under statutory authority and is used for the purpose of maintaining publicly searchable registers and indexes.

Lodged by	
Name:	
Phone:	
Address:	
Reference:	
Customer code:	

This memorandum contains provisions which are intended for inclusion in plans under the Subdivision Act 1988 to be subsequently lodged for registration.

**Operative words including words to bind the burdened land and words of annexation must not be included.**

---

Provisions to apply to the plan:

**Burdened land:** As set out in the plan.

**Benefited land:** As set out in the plan.

#### Covenants:

##### 1 Preliminary

The matters addressed in this MCP are those that vary from the provisions in the Regulations and Scheme. All provisions not addressed in this MCP are as required in the Regulations and Scheme.

This MCP is retained by the Registrar of Titles pursuant to section 91(A) of the Transfer of Land Act.

##### 2 Provisions

The Plan of Subdivision includes a notice of restriction enabling approved building envelopes in accordance with Regulation 5 in Part 1 of the Regulations. The provisions of this MCP are incorporated into the restrictions created by the Plan of Subdivision.

Any building to be constructed on allotments to which this MCP applies and for which the construction would require a building permit must be sited within the approved building envelope subject to any specific encroachments allowed outside the approved building envelope pursuant to this MCP. Allotments denoted by \* on the building envelope plan are subject to non-habitable building structure exemptions.

---

35402012

V3

1. The provisions are to be numbered consecutively from number 1.
2. Further pages may be added but each page should be consecutively numbered.
3. To be used for the inclusion of provisions in plans.

91ATLA

Page 1 of 13

**THE BACK OF THIS FORM MUST NOT BE USED**

Land Use Victoria contact details: see [www.delwp.vic.gov.au/property](http://www.delwp.vic.gov.au/property)>Contact us

# Memorandum of common provisions

## Section 91A Transfer of Land Act 1958

The conditions set out in the Small Lot Housing Code (SLHC) apply to any allotment marked with a '▲' on the building envelope plan. All allotments on this plan denoted with a '▲' on the building envelope plan are to be considered either Type A or Type B allotments.

### 3 Text of restrictions

The matters which are restricted by the approved building envelopes provide for siting and design parameters different from those contained in Part 5 in the Regulations and Clause 54 in the Scheme and are as follows.

#### 3.1 Minimum street setbacks (Regulation 74 and Clause 54.03-1)

A building must be set back from a street alignment in accordance with Regulation 74 (Minimum street setbacks) in Part 5 of the Regulations and Clause 54.03-1 in the Scheme, except as specified below.

A building on an allotment must be set back from a street boundary not less than the distance specified in respect of that boundary on the following relevant building envelope plan.

In the case of corner lots, buildings must be setback a minimum of 2 metres from the secondary frontage street or, if applicable, the minimum distance noted on the relevant building envelope plan.

#### **Encroachments:**

The following may encroach into the setback distance required above by not more than 1.5m or 3m for allotments denoted by an \* on the building envelope plan.

- Veranda's and porches that have a maximum height of not more than 3.6m metres above the natural ground
- Unroofed balconies that have a maximum height of not more than 4.0 metres above the natural ground
- Eaves, fascia and gutters
- Screens referred to as described in the Building Regulations 2018.
- Decks, steps or landings - less than 800 mm in height

#### **Diagram: Splayed and Curved Street Frontages**

Unless noted on the plan the minimum front setback on a splayed or curved street frontage must be taken in an arc connecting the front street setback line to the side street setback line commencing at the points that are perpendicular to the points where the street alignment commences to arc.

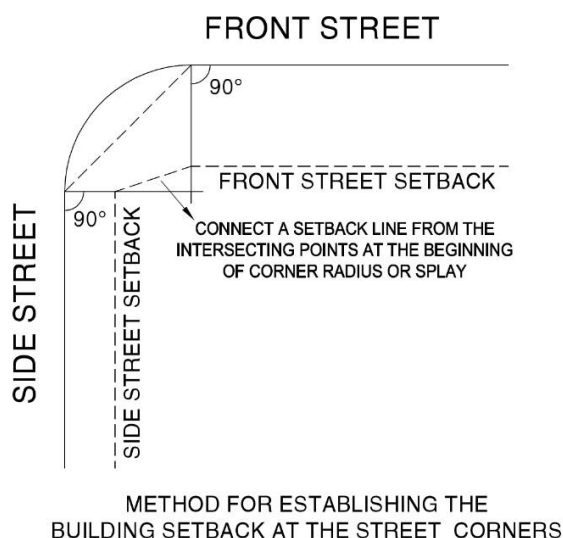

# Memorandum of common provisions

## Section 91A Transfer of Land Act 1958

A garage on an allotment must be set back not less than 5.0 metres from the front street boundary of the allotment and must be set back not less than 0.5 metres behind the front building line (excluding encroachments) of the dwelling.

### 3.2 Building Height (Regulation 75 and Clause 54.03-2)

The height of a building on a lot must be in accordance with Regulation 75 (Building Height) in Part 5 of the Regulations and Clause 54.03-2 in the Scheme, except as specified below.

The height of a building on a lot must not exceed 10.0 metres unless the slope of the natural ground level at any cross section wider than 8 metres of the site of the building is 7.5 degrees or more, in which case the maximum building height should not exceed 12.0 metres.

Non-habitable building structures on allotments denoted by \* on the building envelope plan must comply with the requirements specified in the height and setback profiles noted below and shown on the plan by the identifier code. Where a non-habitable building structure exceeds the height and/or setback parameters the approval of the Responsibility Authority is required.

### 3.3 Site coverage (Regulation 76 and Clause 54.03-3)

The site area covered by buildings and non-habitable building structures on an allotment must be in accordance with Regulation 76 (Site coverage) in Part 5 of the Regulations and Clause 54.03-3 in the Scheme, or the maximum site coverage as specified in the schedule to the zone.

### 3.4 Side and rear setbacks (Regulation 79 and Clause 54.04-1)

Side and rear setbacks on an allotment must be in accordance with Regulation 79 (Side and rear setbacks) in Part 5 of the Regulations and Clause 54.04-1 in the Scheme, except as specified below.

Side and rear setbacks for building elements (such as walls and roof coverings) must comply with the requirements specified in the height and setback profiles noted below and shown on the plan by the identifier code.

A building on a lot which has two side boundaries denoted as 0 or 1 in the plan of subdivision must be setback at least one metre from one of the two side boundaries.

The following may encroach not more than 0.5 metres into the minimum side and rear setbacks or for the allotments denoted by an \* on the building envelope plan 1.5 metres into the minimum side setback and 3.0 metres into the minimum rear setback

- Porches and verandas
- Masonry chimneys
- Screens (to the extent needed to protect a neighbouring property from a direct view)
- Flues and pipes
- Domestic fuel tanks
- Heating and cooling equipment and other services
- Water Tanks

The following may encroach into the minimum setbacks.

- Landings with a maximum area of 2.0 square metres and a maximum height of 1 metre
- Unroofed stairways and ramps
- Pergolas
- Shade sails
- Eaves, fascias and gutters not more than 0.6 metre in total width
- Outbuildings not exceeding 10 square metres in area and 3 metres in height.

A garage with access facing the side street boundary of a corner allotment must be set back at least 0.5 metres behind the side street building line of the dwelling.

Carports may be built on or within 200 millimetres of a side street boundary if the side of the carport facing the boundary is open.

# Memorandum of common provisions

## Section 91A Transfer of Land Act 1958

Non-habitable Building Structures on allotments denoted by an \* on the building envelope plan must comply with the requirements specified in the Text of Restriction Clause 3.11 and the requirements specified in the height and setback profiles noted below and shown on the plan by the identifier code. Where a non-habitable building structure exceeds the side and/or rear setback parameters the approval of the Responsibility Authority is required.

Edge allotments are not beneficiaries of the restriction described above.

### 3.5 Walls on boundaries (Regulation 80 and Clause 54.04-2)

Walls constructed on a boundary must be in accordance with Regulation 80 (Walls on boundaries) in Part 5 of the Regulations and Clause 54.04-2 in the Scheme, except as specified below.

The height of a wall or carport of an allotment must not exceed a maximum height of 3.6 metres unless abutting a higher existing or simultaneously constructed wall.

Non-habitable building structures on allotments denoted by an \* on the building envelope plan must comply with the requirements specified in the Text of Restriction Clause 3.11 and the requirements specified in the height and setback profiles noted below and shown on the plan by the identifier code.

A non-habitable building structure on an allotment denoted by an \* on the building envelope plan with a wall on a side or rear boundary must not exceed a maximum height of 3.6 metres measured from natural ground level and a maximum average height of 3.2 metres measured from natural ground level.

Where a non-habitable building structure on an allotment denoted by an \* on the building envelope plan exceeds the wall on boundary parameters of this Clause and the requirements specified in the height and setback profile noted below and shown on the plan by the identifier code the approval of the Responsibility Authority is required.

Edge allotments are not beneficiaries of the restriction described above

### 3.6 Daylight to existing habitable room windows (Regulation 81 and Clause 54.04-3)

The provision of solar access to existing north-facing habitable room windows must be in accordance with Regulation 81 (Daylight to existing habitable room windows) in Part 5 of the Regulations and Clause 54.04-3 in the Scheme, except as specified below.

A building must be set back from a habitable room window in an existing building on an adjoining lot to provide for a light court to the existing window that has a minimum area of 3 square metres and a minimum dimension of 1m clear to the sky. The area of the light court may include land on the adjoining lot.

A wall or carport with an average height of more than 3.6 metres opposite a habitable room window in an existing dwelling on an adjoining lot must be setback from the window at least half the height of the wall or carport if the wall or carport is within a 55 degree angle in the horizontal plane about a vertical axis through the centre of the window. The angle may be swung to not less than 35 degrees from the plan of the wall containing the window.

This is illustrated in the two diagrams below.

# Memorandum of common provisions

## Section 91A Transfer of Land Act 1958

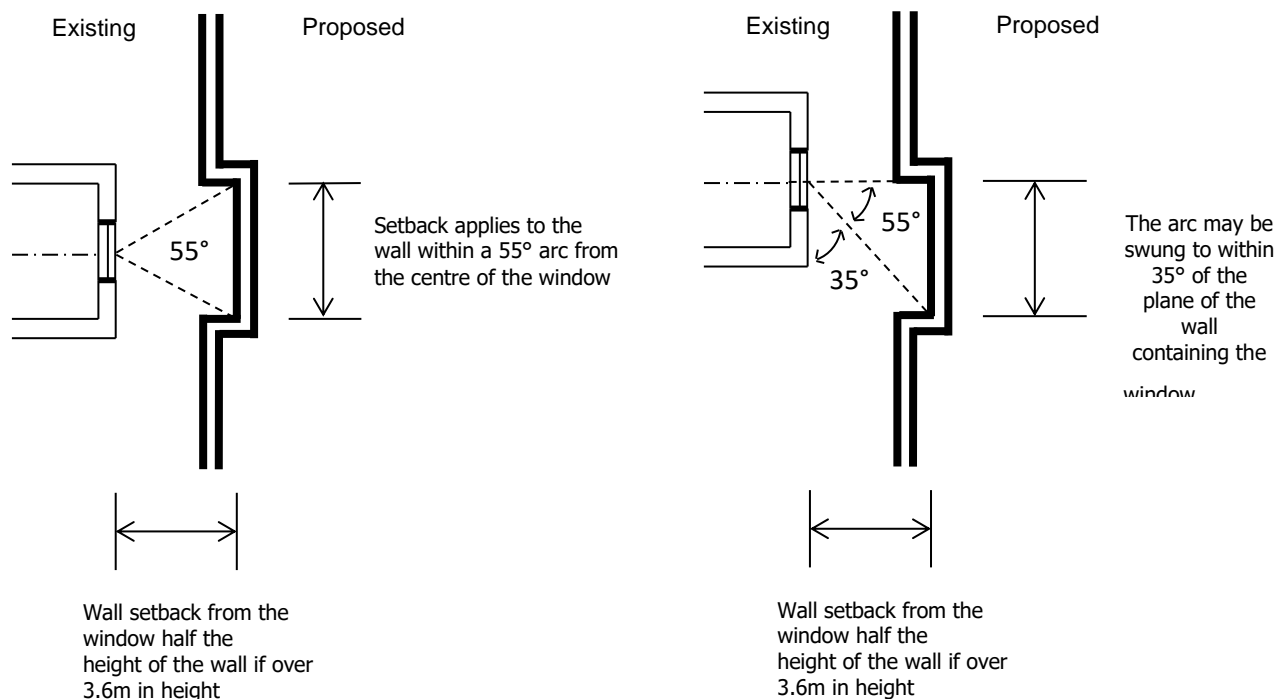

If the existing habitable room window is above ground level, the wall or carport height is measured from the floor level of the room containing the window.

Daylight to habitable room windows in buildings on lots, which are not beneficiaries of this restriction, is not dealt with by this building envelope except where annotated on plan.

### 3.7 Solar access to existing north-facing habitable room windows (Regulation 82 and Clause 54.04-4)

The provision of solar access to existing north-facing habitable room windows must be in accordance with Regulation 82 (Solar access to existing north-facing habitable room windows) in Part 5 of the Regulations and Clause 54.04-4 in the Scheme, except as specified below.

Reference to an existing north-facing habitable room window, in the case of buildings on allotments contained within this MCP, refers to ground floor windows only.

Any north-facing habitable room window at ground level to be constructed in a building on an allotment must be clear to the sky and setback within the building envelope of the north boundary of that allotment.

### 3.8 Overshadowing of recreational private open space (Regulation 83 and Clause 54.04-5)

Any overshadowing of recreational private open space must be in accordance with Regulation 83 (Overshadowing of recreational private open space) in Part 5 of the Regulations and Clause 54.04-5 in the Scheme, except as varied as a consequence of other restrictions in this MCP.

Edge allotments are not beneficiaries of the restriction described above.

# Memorandum of common provisions

## Section 91A Transfer of Land Act 1958

### 3.9 Overlooking (Regulation 84 and Clause 54.04-6)

Any overlooking of a habitable room window or secluded private open space of an existing dwelling on an adjoining allotment must be in accordance with Regulation 84 (Overlooking) in Part 5 of the Regulations and Clause 54.04-6 in the Scheme, except as varied as a consequence of other restrictions in this MCP.

This requirement applies to any habitable & non-habitable building structure room window, balcony, terrace, deck or patio of a dwelling on an allotment within the specified overlooking control area (as indicated in the relevant height and setback profiles), that has direct views into an adjoining allotment.

Edge allotments are not beneficiaries of this restriction described above.

### 3.10 Private open space (Regulation 86 and Clause 54.05-2)

A dwelling on an allotment must provide private open space as specified in Regulation 86 (Private open space) in Part 5 of the Regulations and Clause 54.05-2 in the Scheme.

### 3.11 Non-habitable building structures, Class 10a & Other Structures, Class 10b (Regulation 97)

Allotments denoted by \* on the building envelope plan are subject to the following non-habitable building structure exemptions and are subject to the requirements specified in the height and setback profiles noted below and shown on the plan by the identifier code. Non-habitable building structures identified on the plan by the identifier code are limited to below:

- Class 10a & Class 10b Structures

Further to the above, any masts, poles, ariel, antenna, chimney, flue, or service pipe must be in accordance with Regulation 97 (Masts, Poles etc.) in Part 5 of the Building Regulations 2018. This requirement applies to any masts or poles when not attached to a building, must not exceed 8m above the natural ground level.

In the circumstance where a non-habitable building structure does not comply with this Clause and the requirements specified in the height and setback profile noted below and shown on the plan by the identifier code the approval of the Responsibility Authority is required.

## 4 Notes on the MCP

- 4.1 Ground level after engineering works associated with subdivision is to be regarded as natural ground level.
- 4.2 In the case of conflict between the plan and these written notations, the specifications in the written notations prevail.
- 4.3 Buildings must not cover registered easements unless provided for by the easement.
- 4.4 Edge allotments are those allotments that are part of the same certified plan of subdivision but share one or more common boundaries with or otherwise adjoin an allotment that is not part of the same certified plan of subdivision. Regulation 71 in Part 5 of the Regulations and Clause 56.04-2 in the Scheme, apply to each edge allotment irrespective of Sections 1 to 3 of this MCP.
- 4.5 Non-habitable building structures set out in the Text of Restriction Clause 3.11 cannot be deviated unless the approval of the Responsibility Authority is obtained.

# Memorandum of common provisions

## Section 91A Transfer of Land Act 1958

### 5 General definitions

If not defined above, the words below shall have the meaning attributed to them in the document identified.

In the *Building Act 1993*:

- Building

In Parts 1, 5 & Schedule 12 of *Building Regulations 2018*:

- Clear to the sky
- Height
- Private open space
- Recreational private open space
- Raised open space
- Secluded private open space
- Setback
- Site coverage
- Single dwelling
- Allotment
- North (true north)
- Non-habitable Building Structures (Class 10a & 10b)

In the *Hume Planning Scheme*:

- Frontage (Clause 72)
- Dwelling (Clause 74)
- Habitable room (Clause 72)
- Storey (Clause 72)

#### **Additional definitions:**

##### **Approved building envelope**

The building envelope shown for a particular allotment in the building envelope plan and has the same meaning as in Regulation 71 of the Regulations.

##### **Building envelope**

An area within each allotment (defined by the particular allotment setbacks) where development of a dwelling, shed, garage or carport is allowed subject to the particular provisions of this document, the Permit and the Scheme.

##### **Building envelope plan**

The plan which is attached to this MCP and which shows the approved building envelopes, certain setbacks and other related matters for the allotments within the plan of subdivision.

##### **Corner allotment**

An allotment with a corner where each boundary connects to a street (excluding a laneway) or public open space.

##### **Edge allotments**

Allotments that are part of the same certified plan of subdivision but share one or more common boundaries with or otherwise adjoin an allotment that is not part of the same certified plan of subdivision.

##### **Finished Surface Level**

The ground level after engineering works associated with the subdivision are complete.

##### **Non-Habitable building structure**

Consisting of; Class 10a & Class 10b structures (Text of Restriction 3.11)

##### **MCP**

This Memorandum of Common Provisions.

# Memorandum of common provisions

## Section 91A Transfer of Land Act 1958

### **On the boundary**

Setback of up to 200 millimetres from the allotment / property boundary is deemed to be on the boundary.

### **Plan of Subdivision**

The Plan of Subdivision referred to on page 1 of this MCP.

### **Regulations**

The Building Regulations 2018 or any subsequent regulations made pursuant to the Building Act which relate to the siting of a building.

### **Scheme**

The Hume Planning Scheme.

### **Side boundary**

A boundary of an allotment that runs between and connects the street frontage of the allotment to the rear boundary of the allotment.

### **Small Lot Housing Code (SLHC)**

The Small Lot Housing Code for allotments less than 300m<sup>2</sup> incorporated into the Hume Planning Scheme.

### **Street**

For the purposes of determining street setbacks, street means any road other than a footway or carriageway easement.



**Memorandum of common provisions**  
**Section 91A Transfer of Land Act 1958**

**6 Diagrams and plans**



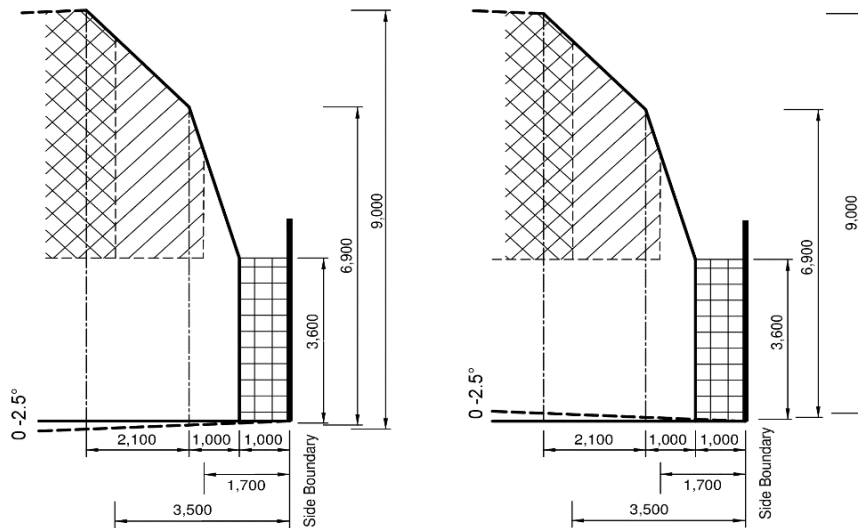

**6.1 Profiles referenced in the building envelope plan**

**0 - 2.5° Slope**  
**STANDARD ALLOTMENT:**

**A**



**TYPICAL SIDE BOUNDARY**

-  Single Storey Building Envelope
-  Overlooking Zone  
Habitable room windows/Raised open spaces are a source of overlooking.
-  Non Overlooking Zone  
Habitable room windows/Raised open spaces are not a source of overlooking.
-  Building to Boundary Zone



**Memorandum of common provisions**  
**Section 91A Transfer of Land Act 1958**

0 - 2.5° Slope  
 STANDARD ALLOTMENT:

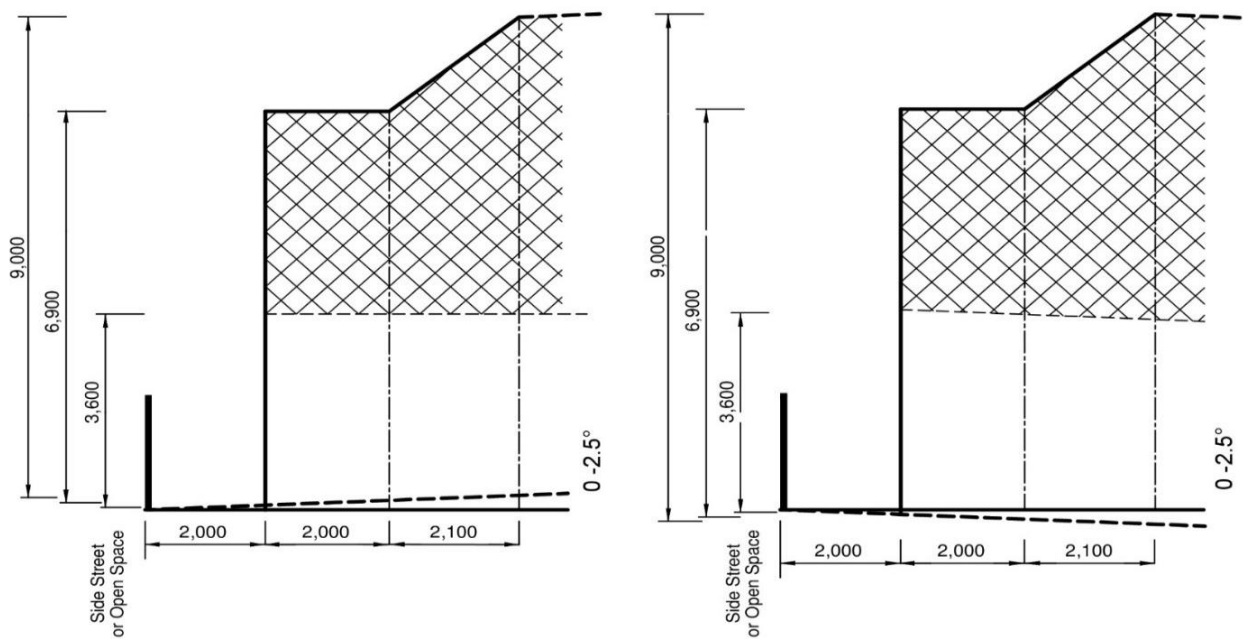
**S1**

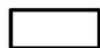

Side boundary abuts street  
 or public open space

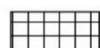
-  Single Storey Building Envelope
-  Overlooking Zone  
Habitable room windows/Raised open spaces are a source of overlooking.
-  Non Overlooking Zone  
Habitable room windows/Raised open spaces are not a source of overlooking.
-  Building to Boundary Zone

**Memorandum of common provisions**  
**Section 91A Transfer of Land Act 1958**

0 - 2.5° Slope  
STANDARD ALLOTMENT:

S2

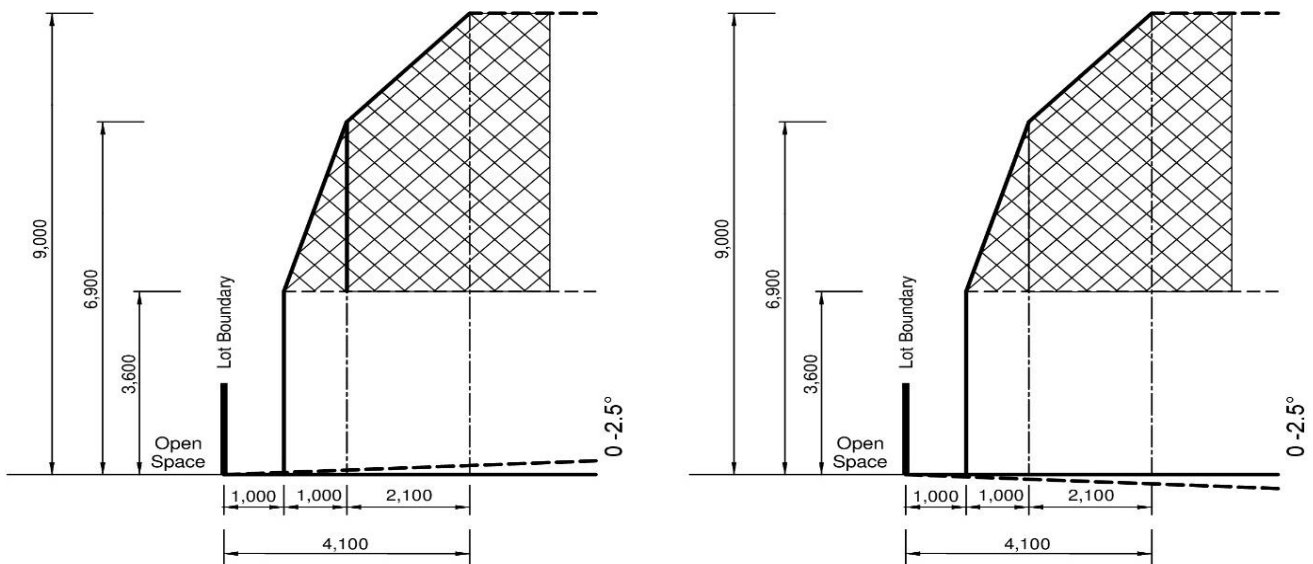

Side boundary abuts Reserve

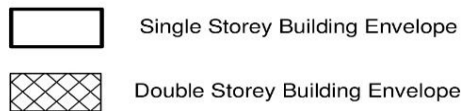

# 0 - 2.5° Slope

## STANDARD ALLOTMENT:

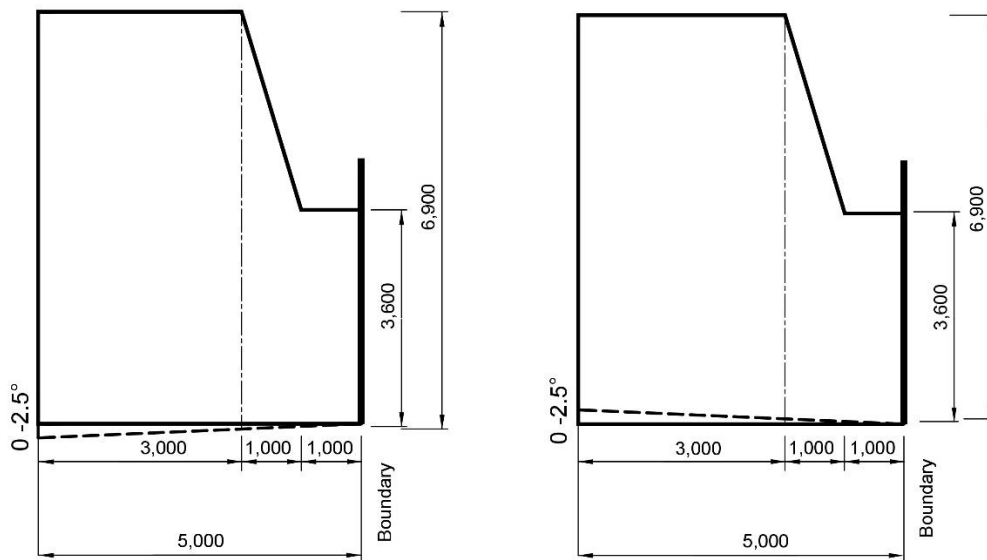
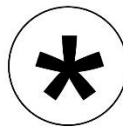

Typical Side and Rear Boundary for lots marked with \*

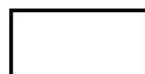

Non-habitable Building Envelope

# Memorandum of common provisions

## Section 91A Transfer of Land Act 1958

### 6.2 Plan of Subdivision showing building envelope height and setback profile identifier code



**Expiry:** As set out in plan.